



# AC DRIVE SYSTEM TMdrive™ -MV MEDIUM VOLTAGE INVERTER



Закрытое акционерное общество  
**Автоматика-Север**



197376 Россия, Санкт-Петербург, ул. Льва Толстого 7, офис 311 <http://www.avt.com.ru>  
тел: (812) 335-19-48, (812) 718-32-38 факс: (812) 718-32-39 E-mail: [as@avtsev.spb.ru](mailto:as@avtsev.spb.ru)

**ЗАО “Автоматика-Север”  
представляет  
средневольтовые инверторы**

**To users of our inverters:** Our inverters are designed to control the speeds of three-phase induction motors for general industry.



## PRECAUTIONS

- Read the entire “Instruction Manual” carefully for important information about safety, handling, installation, operation, maintenance, and parts replacements.
- When using our inverters for equipment such as nuclear power control equipment, aviation and space flight control equipment, traffic equipment, and safety equipment, and there is a risk that any failure or malfunction of the inverter could directly endanger human life or cause injury, please contact our headquarters, branch, or office printed on the front and back covers of this catalogue. Such applications must be studied carefully.
- When using our inverters for critical equipment, even though the inverters are manufactured under strict quality control, always fit your equipment with safety devices to prevent serious accident or loss should the inverter fail (such as failure to issue an inverter trouble signal).
- Do not use our inverters for any load other than three-phase induction motors.

- Windows is a registered trademark of Microsoft Corporation in the United States and/or other countries.
- Device Net is a registered trademark of ODVA (Open Device Net Vendor Association, Inc.).
- Profibus-DP is a trademark of Profibus International.
- Modbus Plus is a trademark of Schneider Electric Inc.
- Ethernet is a registered trademark of Xerox Corporation.
- TOSLINE is a registered trademark of Toshiba Corporation.
- TMdrive is a registered trademark of Toshiba Mitsubishi Electric Industrial Systems Corporation.
- All other registered trademarks and trademarks are the property of their respective companies.
- All specifications in this document subject to change without notice.

**TOSHIBA MITSUBISHI-ELECTRIC INDUSTRIAL SYSTEMS CORPORATION**



# TMdrive-MV is a clean wave inverter.

## Direct drive for medium voltage induction motor, realizing high efficiency and high input power factor

TMdrive-MV is a medium voltage IGBT inverter with the concept of “clean wave”. This inverter has been developed on the basis of the latest “state-of-the-art” AC drive technology for large industrial plants and the world-renowned advanced technology in power electronics.

Applying TMdrive-MV instead of a damper or a control valve can achieve a significant energy saving by driving a medium voltage induction motor at variable speed for square torque loads such as fan, pump and blower.

Characteristics of TMdrive-MV make them an ideal variable speed drive for medium voltage motor including existing motor.



### 1 Power Source and Motor friendly

- Harmonic currents are reduced by 18 pulse rectification using a special designed transformer
- The harmonic contents meet IEEE519 requirements
- Output current close to sine wave by multi-level PWM technology
- No derating of motor output capacity required
- Standard motor is applicable since the switching surge voltage is small owing to unique PWM switching control

### 2 High Efficiency

- Less harmonic contents reduce the harmonic loss of the motor
- Higher efficiency by eliminating output transformer
- Higher efficiency by reducing the number of IGBTs

### 3 High Power Factor

- High power factor by using diode bridge rectifiers (Approx. 95% or more at input transformer primary)

### 4 Saving energy

- TMdrive-MV realizes energy saving by variable speed control for square torque loads such as fan, blower and pump as well as by its high efficiency

### 5 High Reliability

- By using IGBT with rated voltage of 1700V, the number of parts are reduced and the reliability of main circuit is increased
- Use of 32 bit micro processor (model PP7) specifically designed for power electronics applications reduces the number of parts and increases the reliability of the control

## What is TMdrive-MV?

# TMdrive-MV has many unique features.

### Reducing the harmonic currents in the input current

- Equivalent to 18 pulse rectification
- Meet IEEE519 requirements
- No power factor correction capacitor and no harmonic filter required

### Stable speed control without a speed sensing device

- No speed sensor required
- New V/f constant control with sensorless vector control enables a stable speed control
- The vector control with a speed sensor (resolver or pulse generator) is available (option)

### TMdrive-MV can drive a standard motor

- **Retrofit friendly**
  - Output current of TMdrive-MV close to sine wave by multi-level PWM control
  - Small switching surge voltage owing to unique PWM control
  - No derating of motor output capacity required
- **Direct drive of medium voltage induction motor**
  - No step up transformer required
  - By reducing the output current with medium voltage output, the cable size between the inverter and the motor is reduced compared with that of the conventional LV inverter drive
- **Can be used for constant torque and high starting torque applications such as extruder and mixer**
- **Can be used as a soft starter to solve the following problems**
  - Starting frequency problem due to large load  $GD^2$
  - Bus voltage drop problem at direct on line starting



● Control board

### Tough operation at a momentary power failure

- **Ride-through control**
  - When a momentary power failure and the voltage dip occur, TMdrive-MV can continue to operate (within 300 msec).
- **Automatic restarting function**
  - After input power recovery, the coasting motor can be restarted smoothly and automatically.

### User friendly

- **Easy engineering**
  - Packaged type design with input transformer
  - No harmonic filter required
  - No power factor correction capacitor required
  - Standard motor applicable
  - Smaller output cable size compared with that of conventional LV inverter
- **Easy operation and diagnostics**
  - Large LCD display is provided for easy operation

### Easy maintenance

- **Front maintenance**
  - Each cell inverter can be drawn out from the front of the panel
- **Air cooled type**
  - Each panel is cooled by the cooling fan mounted on the top of the panel
  - Front access type air filters are provided
- **Drawable type cell-inverter construction**



● Cell-inverter



● Inverter Panel



## Features of TMdrive-MV

# TMdrive-MV is a clean wave inverter.

### Clean Input Wave

## Harmonic currents are reduced by 18 pulse rectification using a special designed transformer.

In recent years, use of industrial equipment with power electronics are increasing due to a rapid progress of the semiconductors such as transistors and thyristors. The increasing problems of harmonic currents generated by such large capacity industrial equipment affect the harmonic voltage distortion on the power supply and cause the failure of other equipment.

Therefore, there is a movement to establish harmonic regulation standards to reduce harmonic current contents generated from such power electronic equipment.

To comply with such requirements, TMdrive-MV is designed to reduce harmonic current contents to the power source. By using a specially designed transformer, TMdrive-MV has 18 pulse rectification and meets the requirements of IEEE-519 (1992) and the guideline established by MITI (Ministry of international Trade and Industry) in Japan.

#### ● Input wave forms of TMdrive-MV

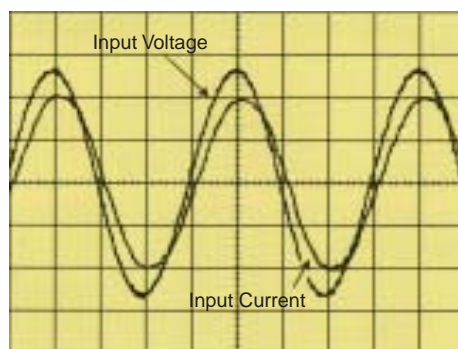

#### ● Harmonic current contents of input current

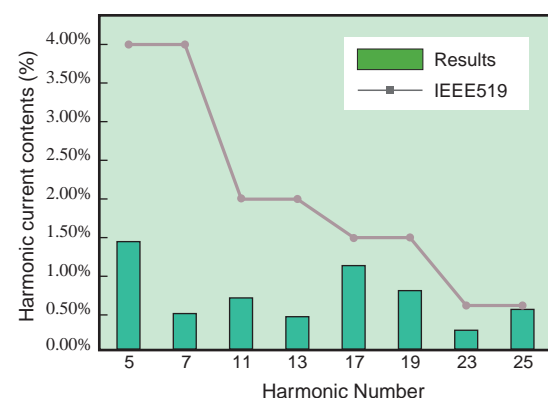

#### ● Harmonic current contents of input current

Individual harmonic order (odd)	5th	7th	11th	13th	17th	19th	23th	25th
TMdrive-MV*1 (%)	1.4	0.5	0.6	0.5	1.1	0.6	0.3	0.5
IEEE-519(1992) (%)	4.0	4.0	2.0	2.0	1.5	1.5	0.6	0.6

\*1 Result of actual load test (1800kVA)

#### ● The policy of the Guideline in Japan

The guideline sets the upper limit of harmonic currents level and maintains the harmonic voltage distortion in the electrical power system below the harmonics environment target level. This guideline does not apply to the existing system at the plant, but if additions are made to those systems or the conditions of the contract changes, they become subject to the guideline. If harmonics of those systems exceed the upper limit specified by the guideline, certain measures have to be taken to meet the requirement of the guideline.

#### ◎ Method to comply with the guideline/example calculation

TMdrive-MV produces very low harmonic currents and is stress free to power source. Therefore, it can clear the guideline without using any special measures such as the harmonic filters. The case study below shows how much harmonics are produced when applying TMdrive-MV, how to follow the guideline, and example calculations.

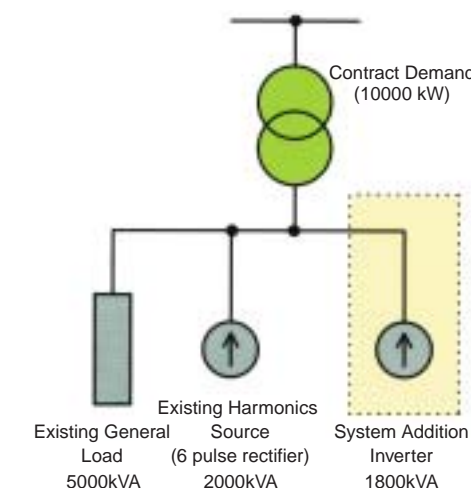

#### To the existing system

(Receiving voltage = 6.6kV, contract demand = 10000kW), installing a 1800kVA inverter additionally.

#### Existing load condition:

● General load: 5000kVA Maximum operation rate 100%

● 6 pulse rectifier load: 2000kVA Maximum operation rate 100%

#### Addition:

● TMdrive-MV: 1800kVA Maximum operation rate 100%

#### ● Harmonic current contents of existing system (6.6kV base)

Harmonic order	5th	7th	11th	13th	17th	19th	23th	25th
Harmonic current (%)	17.5	11.0	4.5	3.0	1.5	1.25	0.75	0.75
Harmonic current (A)	30.6	19.2	7.9	5.2	2.6	2.2	1.3	1.3

#### ● Harmonic current contents from TMdrive-MV (6.6kV base)

Harmonic order	5th	7th	11th	13th	17th	19th	23th	25th
Harmonic current (%)	1.4	0.5	0.6	0.5	1.1	0.6	0.3	0.5
Harmonic current (A)	2.2	0.8	0.9	0.8	1.7	0.9	0.5	0.8

#### ● Harmonic current contents after TMdrive-MV added and Allowable upper limit (6.6kV base)

Harmonic order	5th	7th	11th	13th	17th	19th	23th	25th
Total harmonic current contents (A)	32.8	20.0	8.8	6.0	4.3	3.1	1.8	2.1
Upper limit of harmonic current (A)	35.0	25.0	16.0	13.0	10.0	9.0	7.6	7.0

## Features of TMdrive-MV

### Clean Output Wave

#### Output current is close to sine wave owing to multi-level PWM control.

Output voltage wave form is step type sine wave by multi-level PWM control. Also, output current wave form is close to sine wave. Therefore, the additional heat loss caused by the harmonic currents are negligible. Switching surge voltage which causes a damage to the insulation of the motor is smaller compared with that of two level PWM inverter, owing to unique control of the switching of each IGBT. Therefore, no motor kW derating is required and retrofitting application is possible. (In case of the retrofitting application, it should be checked whether the motor and the driven machine are suitable for variable speed operation.)

● Output wave forms of TMdrive-MV

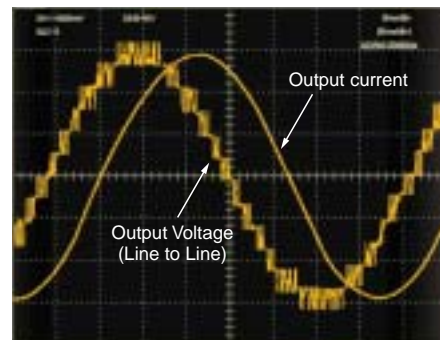

### Clean Output Wave

#### Torque ripple is negligible owing to extremely small harmonic current contents.

If harmonic currents are included in the motor current, a pulsation torque called torque ripple is generated between the stator and the rotor of the motor. Torque ripple causes the torsional vibration torque to the drive shaft and the driven machine. If the frequency of the torque ripple and the torsional natural frequency of the motor and the driven machine train coincide each other, the vibration torque increases due to a resonance. Since very low harmonic currents are included in the output wave form of TMdrive-MV, torque ripple created by the motor shaft is very low and the influence of torque ripple can be ignored for most cases.

### High efficiency

#### The efficiency is higher compared with that of conventional drive system.

TMdrive-MV is high efficiency drive system owing to the followings:

- 1) By reducing the number of semiconductors in power circuit by using 1700V IGBT, the IGBTs' loss is reduced.
- 2) The switching loss of each IGBT is minimized by reducing the switching frequencies using multi level PWM control.
- 3) The loss of the output transformer is eliminated.

The efficiency of TMdrive-MV is expected to be over 97% (97.6% was the measured value at actual load test in our factory for 1800kVA inverter)

Furthermore, the harmonic loss of the equipment on the plant including the driving motor will be reduced owing to the low harmonic current contents in the input and output current of TMdrive-MV.

### High power factor

#### High power factor on the input side of TMdrive-MV through all operating speed range.

TMdrive-MV consists of single phase PWM inverters (cell-inverters) connected serially per phase. As each cell inverter has a diode bridge for the rectifier, the input power factor of TMdrive-MV is expected to be over 95% on all practical operating speed range. Therefore, no power factor correction capacitor is required. Furthermore, the input power factor of TMdrive-MV is high, even when TMdrive-MV drives multiple pole induction motor of low power factor.

● Expected efficiency of TMdrive-MV

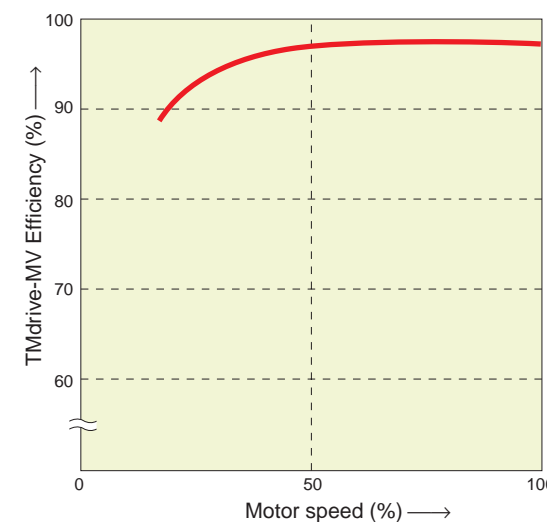

● Expected input power factor of TMdrive-MV

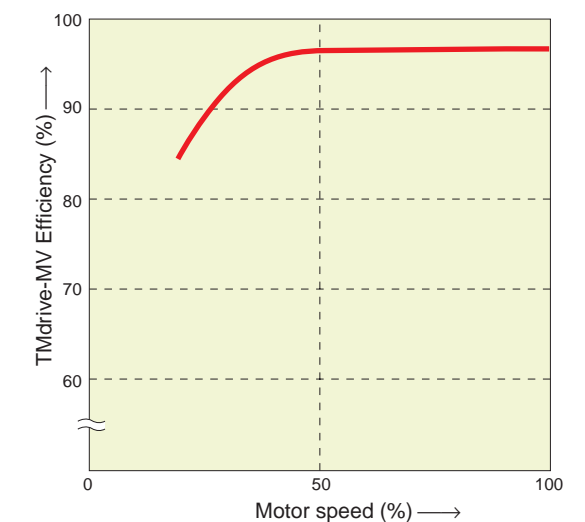

\* Results of the factory test  
\* In case of the square torque machine

Contributing to saving energy

# TMdrive-MV realizes big energy saving by variable speed operation.

Squirrel-cage induction motors are predominantly used on fan and pump applications. When motors are operated at a constant speed with the flow and pressure of the fan or pump controlled with a damper or control valve, great energy loss results.

Losses can be minimized and large energy savings can be realized with inverter speed control instead of control by dampers or control valves. With an inverter the following relations exist:

$$\text{Flow} \propto \text{Speed}$$

$$\text{Required power} \propto \text{Flow}^3$$

For example, at 80% flow (speed), power required =  $(0.8)^3 = 51.2\%$ .

A small flow or speed change, therefore, can result in a significant energy savings.

● Application to Dust-Collection Blowers as used in Steel Industry

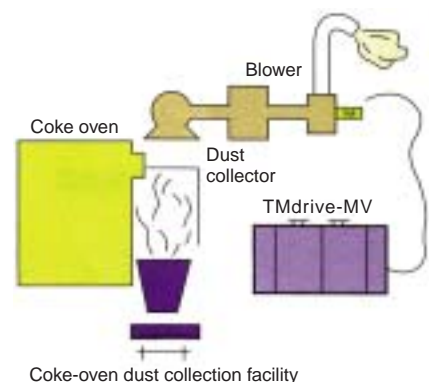

● Application to Induced draft fan (IDF) as used in Boiler

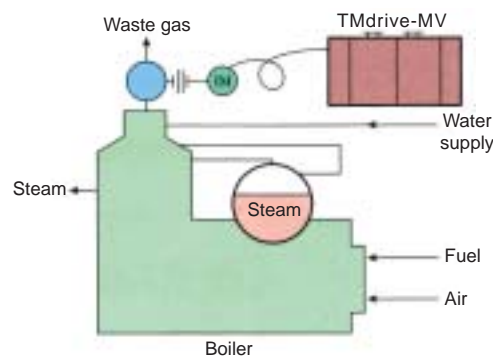

● Application to a waterworks booster pump

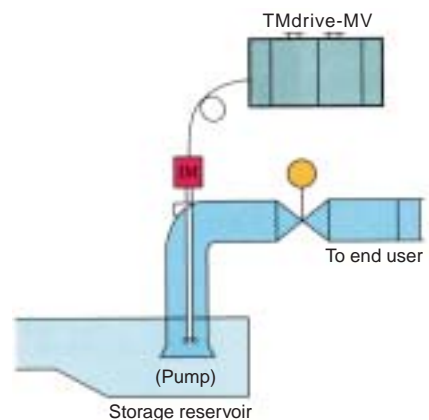

● Application to an Ore-Washing Facility

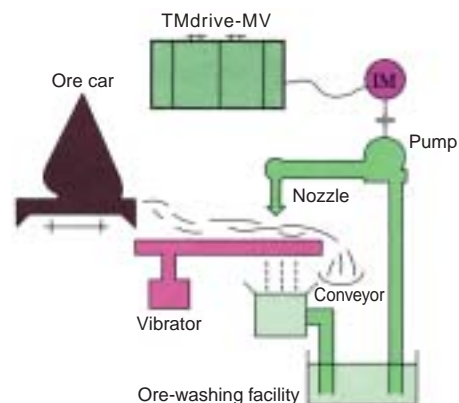

Energy saving calculation example

★ Electrical energy consumption when damper control is applied (Motor is assumed to run at the rated speed)

General relationship between the air pressure (H) and flow rate (Q) of fan and blower are shown below.

(H=1: rated air pressure, Q=1: rated air flow)

The shaft power (P<sub>1</sub>) required when Q=1 is the rated shaft power (kW) of fan (blower).

The shaft power (P<sub>0.7</sub>) required when Q=0.7 is

$$P_{0.7} = P_1 \times Q^{0.7} \times H^{0.7}$$

if the efficiency of fan (blower) is ignored.

Therefore, if the motor efficiency is  $\eta_M$ , the input power P<sub>11</sub> required when Q=1, and P<sub>10.7</sub> when Q=0.7 are

$$P_{11} = P_1 / \eta_M \text{ (kW)}$$

$$P_{10.7} = P_{0.7} / \eta_M \text{ (kW)}$$

(The motor efficiency drop due to load decrease is ignored.)

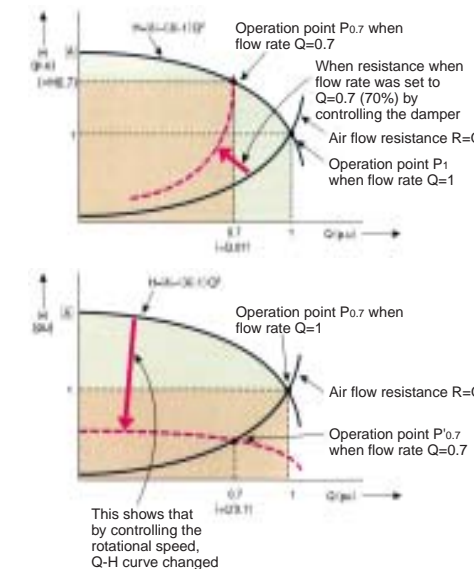

★ Electrical energy consumption when variable speed control was applied using TMdrive-MV

When controlling the flow rate of fans and blowers by controlling the variable speed with inverter, the relations are as shown below.

The required input power P<sub>11</sub> when Q=1 is the same equation as that of the damper control.

$$P_{11} = P_1 / \eta_M \text{ (kW)}$$

When the flow rate is 70% = Q'0.7, the required shaft power P'0.7 is

$$P'_{0.7} = P_1 \times Q'^{0.7} \times H'$$

$$= P_1 \times Q'^{0.7^3}$$

Therefore, the required input power P'10.7 with the inverter efficiency of  $\eta_{INV}$  is

$$P'_{10.7} = P'_{0.7} / \eta_M / \eta_{INV}$$

★ Calculation Example

Efficiency of Motor capacity = 96.5%,

Efficiency of TMdrive-MV = 97% (including transformer)

Shaft power of fan at the rated flow rate: 1100kW

Fan Characteristics: H = 1.4p.u. when Q=0

Annual Run Time: 8000 hours

Operation pattern of Fan:

100%: 20% of annual run time

70%: 50% of annual run time

50%: 30% of annual run time

Electricity Cost: 10 Yen/kWh

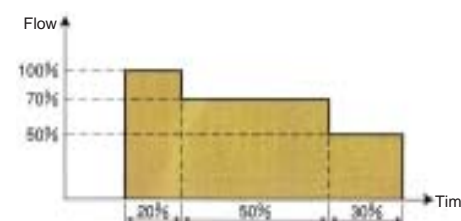

● With damper control

P<sub>100</sub> for 100% flow rate, P<sub>70</sub> for 70% flow rate,

P<sub>50</sub> for 50% flow rate, then

$$P_{100} = 1100 / 0.965 = 1140\text{kW}$$

$$P_{70} = 1100 \times 0.7 \times (1.4 - 0.4 \times 0.7 \times 0.7) / 0.965 = 961\text{kW}$$

$$P_{50} = 1100 \times 0.5 \times (1.4 - 0.4 \times 0.5 \times 0.5) / 0.965 = 741\text{kW}$$

The electricity cost is

$$1140 \times 8000 \times 0.2 \times 10 + 961 \times 8000 \times 0.5 \times 10 + 741 \times 8000 \times 0.3 \times 10 = 74,464,000 \text{ Yen}$$

● With variable speed control

P'100 for 100% flow rate, P'70 for 70% flow rate,

P'50 for 50% flow rate, then

$$P'_{100} = 1100 / 0.965 = 1140\text{kW}$$

$$P'_{70} = 1100 \times 0.7^3 / 0.965 / 0.97 = 403\text{kW}$$

$$P'_{50} = 1100 \times 0.5^3 / 0.965 / 0.97 = 147\text{kW}$$

The electricity cost is

$$1140 \times 8000 \times 0.2 \times 10 + 403 \times 8000 \times 0.5 \times 10 + 147 \times 8000 \times 0.3 \times 10 = 37,888,000 \text{ Yen}$$

● The cost difference between using the damper and the variable speed control is

$$74,464,000 - 37,888,000 = 36,576,000 \text{ Yen/Year}$$



## Operation panel of TMdrive-MV

# Simple operation and maintenance with Operation Panel

- Large LCD display is adopted for the operation panel.
- The operating conditions can be monitored on the operation panel.
- The parameter settings and the failure diagnostics are easy.



Operation panel

### ◎ The functions of the operation panel are as follows.

- LCD graphic display <240×64 dots>
  - Display of operating conditions
  - Display of starting, fault and alarm conditions
  - Display of parameters
- Operational status LED display
- Ethernet connector
- Analog signal Pins
  - Current feedback signal: 2ch
  - User selectable signal for monitor: 5ch
- Interlock switch with protective cover
- Fault reset switch



#### «Main functions»

- Input and change of the parameters
- Display mode change
- Local/remote selection

### ◎ Maintenance Tool (Option)



- Set point control
  - Change of parameter
  - Loading and saving of set point file
  - Comparison between set point files

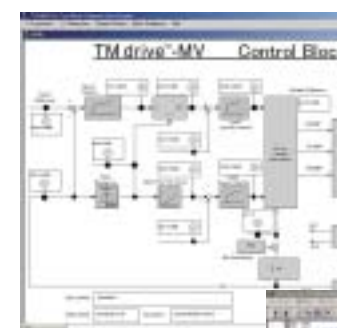

Control block display: speed control

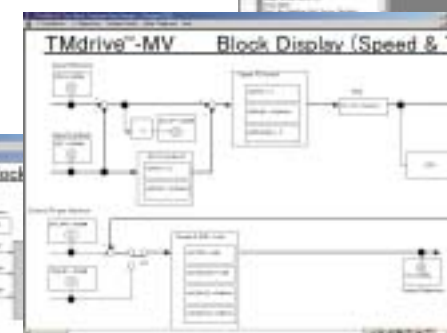

Control block display: overview

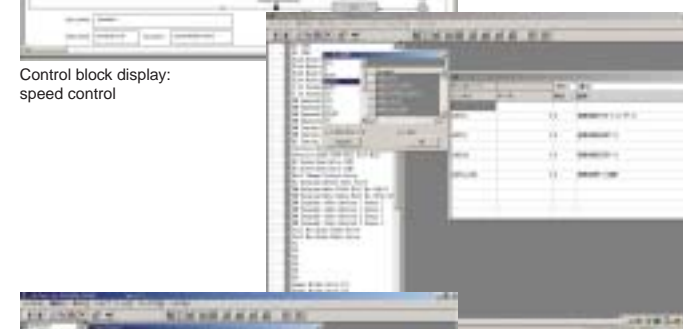

Input of set point



Snapshot

- Troubleshooting
  - First fault display
  - Operation preparation display
  - Fault traceback
  - Trouble records
  - Fault history display
  - Online manual

- Maintenance tool functions
  - Drive equipment can be easily adjusted and maintained using the personal computer (Windows®2000 or Windows®XP). Moreover, several sets of drives can be maintained with Ethernet.

- Support function
  - Control block display
  - Trend display
  - Snap shot function
  - Test operation with simulated signal
  - Response wave display



Main menu

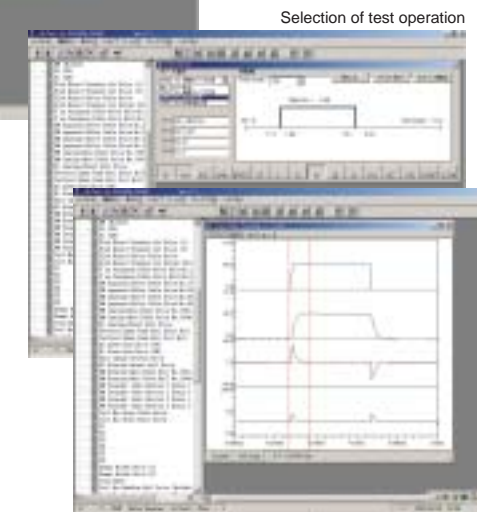

Step response

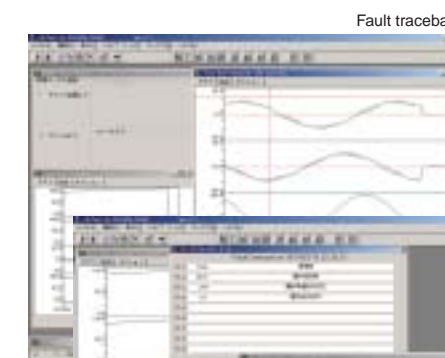

Fault traceback



First fault•Online manual

## Main circuit configuration of TMdrive-MV

### Main circuit configuration

The main circuit of TMdrive-MV consists of the special designed input transformer and single phase PWM inverters (cell-inverters). TMdrive-MV of 3.3kV output consists three cell-inverters connected serially per phase and TMdrive-MV of 6.6kV output consists 6 cell-inverters connected serially per phase.

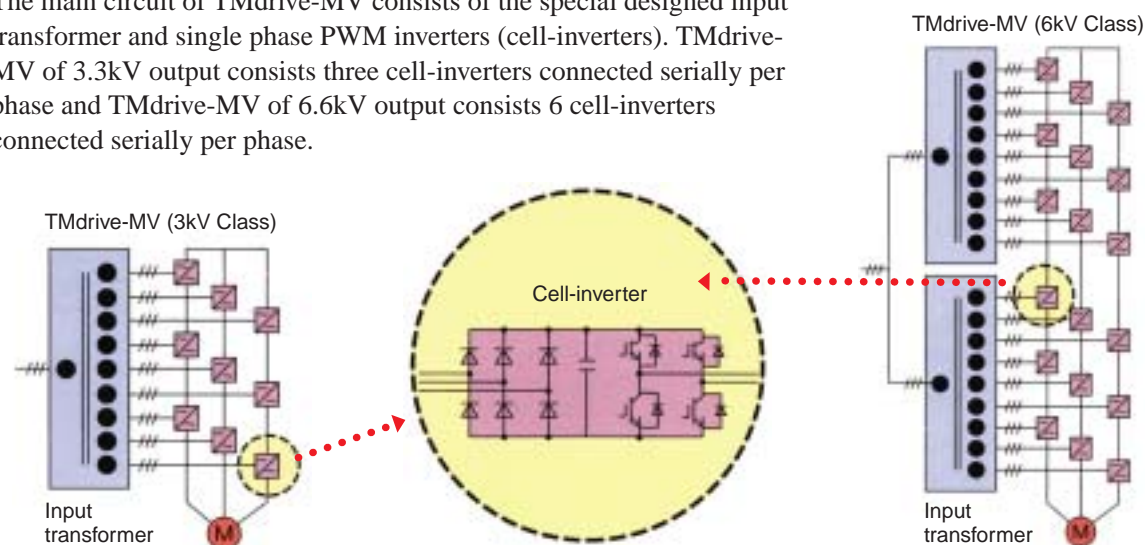

### System configuration

- 1) Motor is operated only by TMdrive-MV.
- 2) Motor is operated by TMdrive-MV as well as by a commercial power supply.

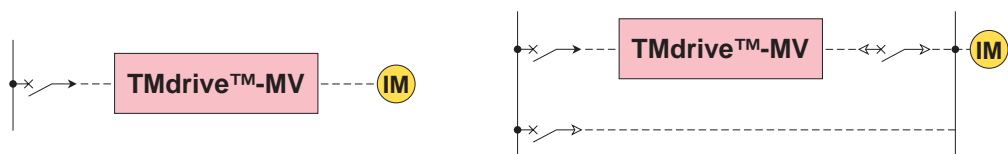

This configuration is recommended for the following applications.

1. When a redundant power supply is required.
2. When a rated speed operation is also required for a certain period.

### Control block diagram

Sensor less vector control will enable a stable speed control. Use of 32 bit micro processor (model PP7) specifically designed for power electronics applications supports the high reliable control.

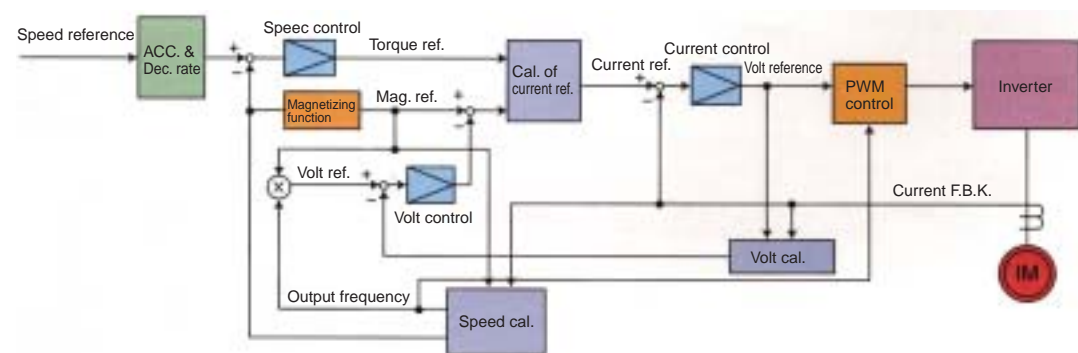

(Optional control)

A vector control system with sensor is available for applications requiring high-precision speed control or those requiring larger starting torque. Simple open loop V/f control is also available.

### Standard connection

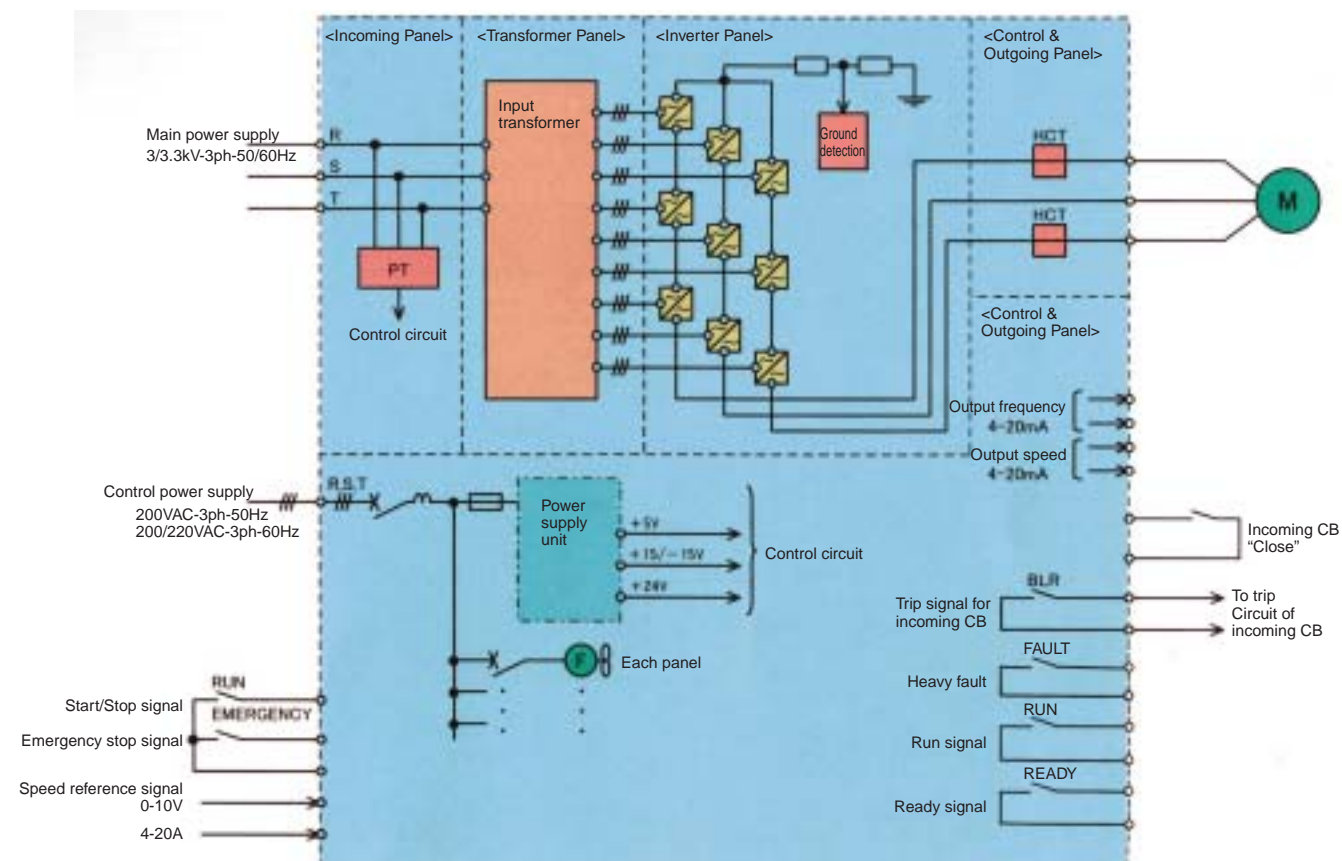

### Standard interface

<Customer→TMdrive-MV>		
Main power supply	Power of main circuit	
Control power supply	Power of control circuit	AC200V-3ph-50Hz or AC200/220V-3ph-60Hz
Start/Stop signal	Close: Run and Open: Stop	Dry contact, DC24V-12mA
Emergency stop signal	Open: Emergency Stop (Free run stop)	Dry contact, DC24V-12mA
Status of incoming CB	Close: Circuit breaker close	Dry contact, DC24V-12mA
Status of outgoing CB (if any)	Close: Circuit breaker close	Dry contact, DC24V-12mA (in the case of system which outgoing CB is required in inverter output)
Speed reference signal	0-10VDC=0-100% or 4-20mADC=0-100%	Input impedance 1M ohm (in the case of voltage signal input) Input impedance 10 ohm (in the case of current signal input)
<TMdrive-MV→Customer>		
Inverter ready signal	Close: Inverter ready	Dry contact Max.AC220V-0.8A,DC110V-0.2A,DC24V-1.5A
Run signal	Close: Run and Open: Stop	
Fault signal	Close: Inverter heavy fault	
Trip signal for incoming CB	Close: To trip incoming CB	
Output current	4-20mADC=0-125% of rated current	Load impedance < 500 ohm
Motor speed	4-20mADC=0-125% of rated current	Load impedance < 500 ohm



Outline dimensions of TMdrive-MV unit: mm

● 3.3kV-200kVA, 300kVA, 400kVA  
<Approx. weight: 3000kg>

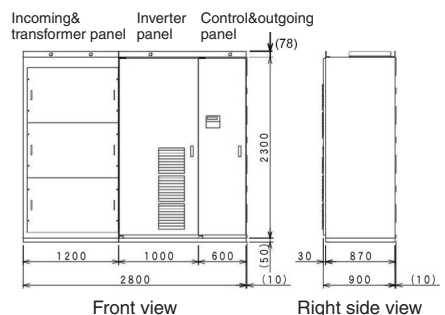

● 3.3kV-500kVA, 700kVA  
<Approx. weight: 3600kg>

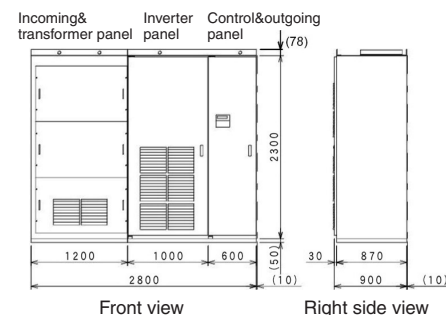

● 3.3kV-900kVA  
<Approx. weight: 4100kg>

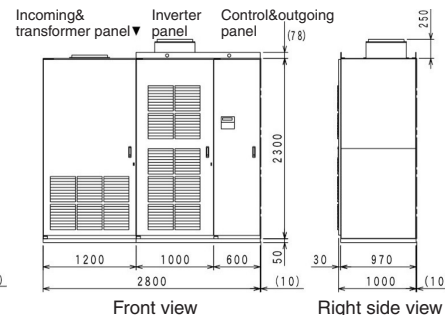

● 6.6kV-1800kVA <Approx. weight: 7000kg>

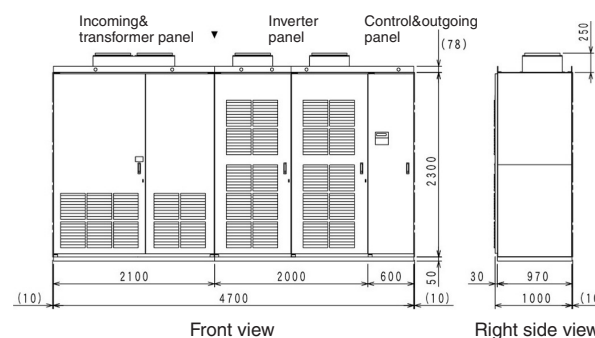

● Approx. dimension of Back to back arrangement

	Width(mm)	Depth(mm)
3.3kV-200 – 400kVA	2200	1805
3.3kV-500, 700kVA	2200	1805
3.3kV-900kVA	2200	2005
3.3kV-1200 – 1800kVA	2700	2005
3.3kV-2400, 3000kV	3400	3005
6.6kV-400 – 800kVA	2200	1805
6.6kV-1000, 1400kVA	3200	1805
6.6kV-1800kVA	3200	2005
6.6kV-2400 – 3600kVA	4800	2005
6.6kV-4200 – 6000kVA	5600	3005

(Note)

1. TMdrive-MV is a front maintenance type construction. The following maintenance space is required on the front side of the panels.  
Below 3.3kV-1800kVA and 6.6kV-3600kVA: over 1700mm  
Above 3.3kV-2100kVA and 6.6kV-4200kVA: over 2000mm
2. Over 700mm of space is required for cooling between the top of the panel and ceiling.
3. Shipping split of TMdrive-MV is between the transformer panel and the inverter panel.
4. The transformer and the transformer panel are to be shipped separately.
5. The back to back arrangement of the panels will be available. (optional)

● 3.3kV-1200kVA, 1500kVA, 1800kVA  
<Approx. weight: 7000kg>

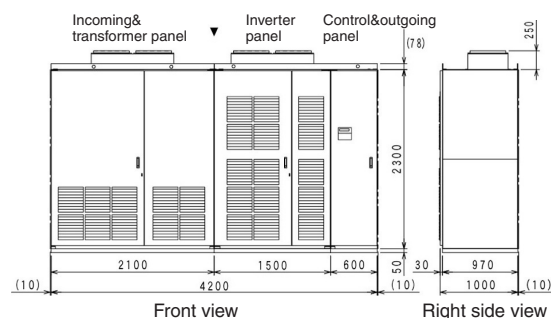

● 3.3kV-2400kVA, 3000kVA  
<Approx. weight: 9400kg>

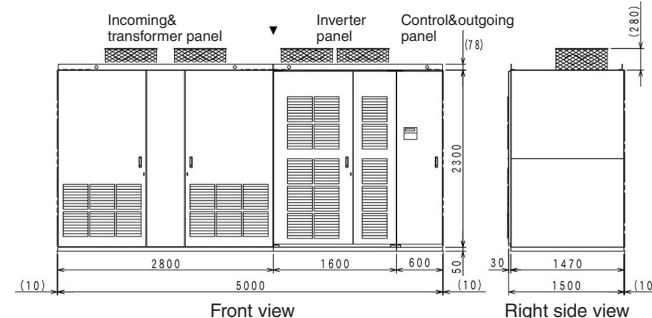

● 6.6kV-2400kVA, 3000kVA, 3600kVA <Approx. weight: 13400kg>

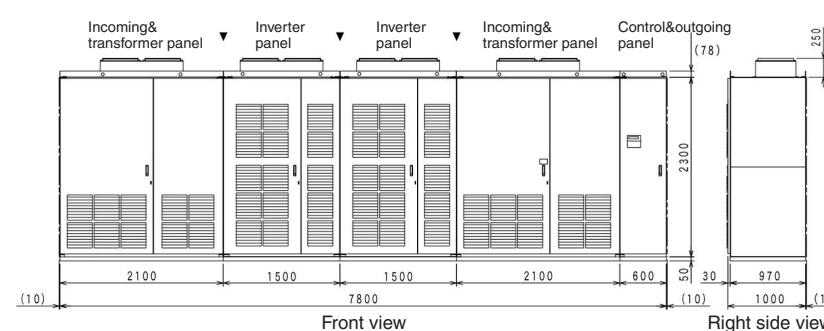

● 3.3kV-4200kVA  
<Approx. weight: 17000kg>

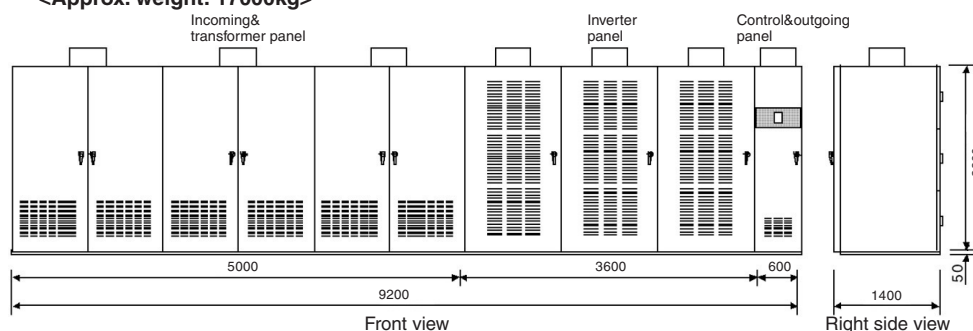

● 6.6kV-4200kVA, 4800kVA, 5400kVA, 6000kVA <Approx. weight: 22000kg>

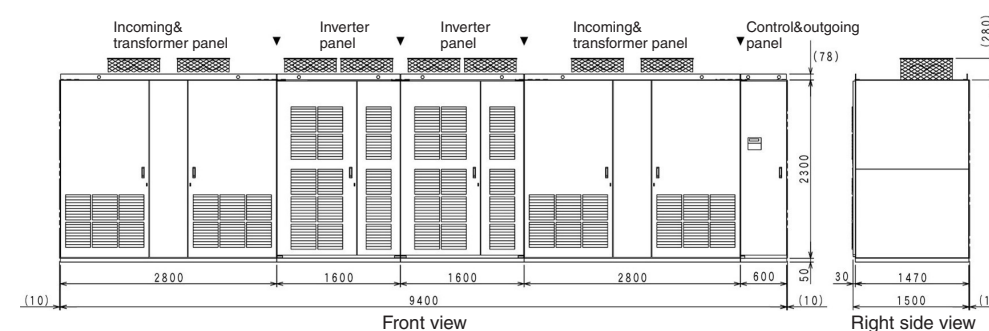

● 6.6kV-400kVA, 600kVA, 800kVA  
<Approx. weight: 4200kg>

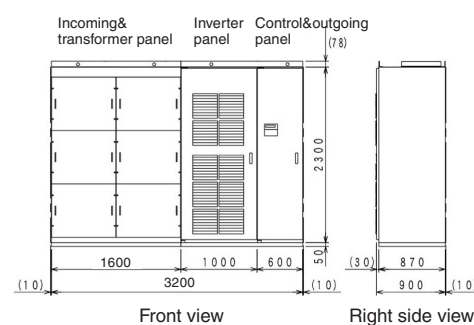

● 6.6kV-1000kVA, 1400kVA  
<Approx. weight: 6000kg>

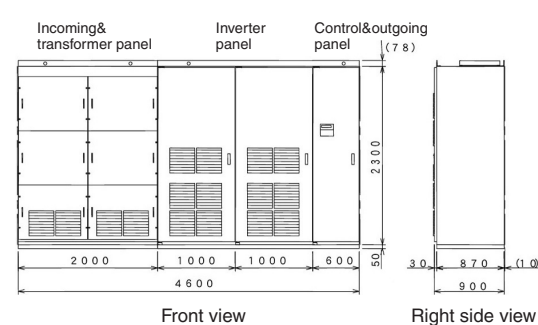

● 6.6kV-8500kVA <Approx. weight: 32000kg>

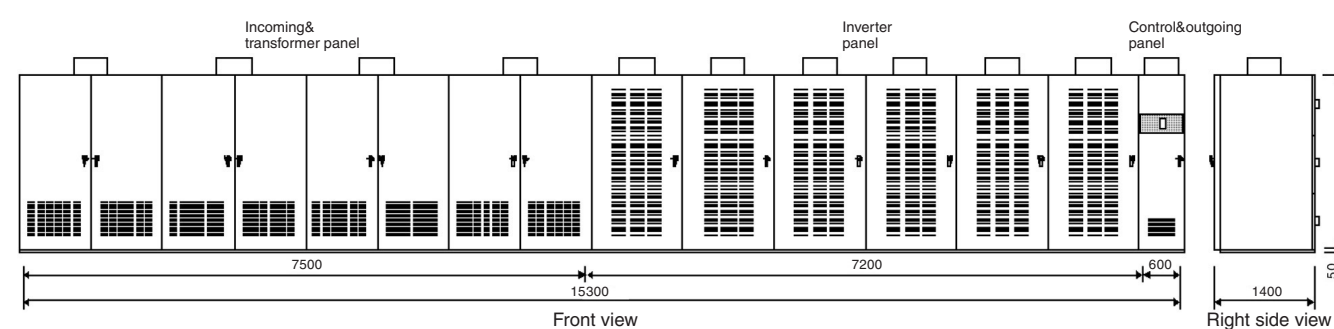

# Specifications of TMdrive-MV

## Specifications

Item	Standard specifications																
<b>Voltage class</b>	3300/3000V																
<b>3.3kV Output Capacity (kVA)</b>	200	300	400	500	700	900	1000	1200	1500	1800	2000	2400	3000	3400	4200		
<b>3.0kV Output Capacity (kVA)</b>	180	270	360	450	630	810	900	1090	1360	1630	1810	2180	2720	3090	3810		
<b>Rated output current (A)</b>	35	53	70	88	123	158	175	210	263	315	350	420	525	595	735		
<b>Motor power output (kW)<sup>*1</sup></b>	160	250	315	400	560	750	800	1000	1250	1400	1600	2000	2500	2800	3550		
<b>Voltage class</b>	6600/6000V																
<b>6.6kV Output Capacity (kVA)</b>	400	600	800	1000	1400	1800	2000	2400	3000	3600	4000	4200	4800	5400	6000	6800	8500
<b>6.0kV Output Capacity (kVA)</b>	360	540	720	900	1270	1630	1810	2180	2720	3270	3630	3810	4360	4900	5450	6180	7720
<b>Rated output current (A)</b>	35	53	70	88	123	158	175	210	263	315	350	368	420	473	525	595	744
<b>Motor power output (kW)<sup>*2</sup></b>	315	450	650	850	1120	1400	1600	2000	2500	2800	3150	3550	4000	4500	5000	5600	7100
<b>Output</b>	<b>Output frequency (Hz)</b> 50 or 60 Hz																
	<b>Overload capacity</b> 125%-60sec.																
<b>Input</b>	<b>Main circuit</b> 3 phase 3000/3300V-50/60Hz or 3 phase 6000/6600V-50/60Hz																
	<b>Control circuit</b> 3 phase 200V-50Hz or 3 phase 200/220V-60Hz																
	<b>Tolerance</b> Voltage: ±10%, Frequency: ±5%																
<b>Power factor of Main power supply</b>	Approx. 95% or more at normal operating speed																
<b>Control Specification</b>	<b>Control method</b> Sensorless vector control + Multi-level sinusoidal PWM (Pulse Width Modulation)																
	<b>Frequency precision</b> ±0.5% of maximum output frequency (Analogue input)																
	<b>Torque characteristics of load</b> Square torque load, Constant torque load																
	<b>Acceleration/deceleration time</b> 0.1 ~ 3270 sec. (depend on GD <sup>2</sup> of load machine)																
	<b>Main control functions</b> Soft stall (Automatic load reduction control during overload), Ride-through function, Specific Frequency Evasion Function, Total run time display function, Non-stop operation during speed reference loss, Multiple Acc./Dcc. Rate setting																
	<b>Main protective functions</b> Current limit, Overcurrent, Overvoltage, Overload, Undervoltage, Ground fault, CPU error, Cooling fan abnormal																
	<b>Data Transmission</b> DeviceNet, ProfiBus-DP, ModbusPlus, TOSLINE-S20																
<b>Operation board</b>	<b>Display</b> LCD display 3 LED's (READY, RUN, FAULT/ALARM)																
	<b>Push buttons</b> NAVIGATION keyboard, CONTROLS keyboard Start, Stop, Reset Fault, INTERLOCK (Emergency stop)																
<b>Input transformer</b>	Temperature class H, dry type, tapping range ±5%, only for TMdrive-MV																
<b>Construction</b>	<b>Protection degree of Enclosure</b> IP20 (IEC-529)																
	<b>Panel construction</b> Free standing, front maintenance type																
	<b>Cooling</b> Air cooled by ventilation fans mounted on panels																
	<b>Panel color</b> Munsell 5Y7/1																
<b>Ambient Conditions</b>	<b>Ambient temperature</b> 0 ~ 40°C																
	<b>Humidity</b> Max. 85% (No condensation)																
	<b>Altitude</b> 1000 m above sea level or less																
	<b>Vibration</b> 0.5G or less at 10 ~ 50Hz																
	<b>Installation</b> Indoor																
<b>Application</b>	Fan, Blower, Pump, Compressor, Extruder, Mixer etc.																
<b>Standards</b>	Electrical performance: IEC Components and others: JIS, JEC, JEM																

(Note) \*1 Approximate capacity in the case of 3.3kV, 4-pole standard induction machine.  
\*2 Approximate capacity in the case of 6.6kV, 4-pole standard induction machine.  
\*3 Some specification of 3.3kV-3400, 4200kVA and 6.6kV-6800, 8500kVA differ from standard designs. For details, please contact our company representatives.

## Option

Output frequency	Max. frequency 120Hz
Control method	Vector control with speed sensor (Resolver, Pulse generator), V/f control
	Automatic flying restart (for a power failure between 300msec and 6sec) Synchronous transfer (Transfer motor to line, Transfer line to motor)
Maintenance tool	Personal computer software for maintenance and adjustment (OS: Windows®2000, Windows®XP)
Others	Separate installation of input transformer: Please consult our company representatives
	Specified panel painting color
	Control panel outlet, Control panel illumination light, space heater

## Items to be Informed

★ Please designate the following items on your inquiry.

- Application (specific load equipment or line name)**
- Type of load equipment** (fan, blower, pump, compressor, etc.)
- Torque characteristics of the load equipment** (Square torque, Linear torque, Constant torque, etc.)  
Load Inertia on motor shaft basis (GD<sup>2</sup>):  (kg·m<sup>2</sup>)  
Speed-torque curve of the load equipment:  (kg·m<sup>2</sup>)
- Driving Motor**  
New or Existing: Power Output:  (kW) Number of Poles:  (P)  
Rated Current:  (A) Rated Voltage:  (V) Rated Speed:  (min<sup>-1</sup>)  
Rated Frequency:  (Hz)
- Main Circuit Input Voltage-Frequency:**  (V)–  (Hz)
- Control Power Supply Voltage-Frequency:** 3 Phase 3 Line–200V–50Hz or 200/220V–60Hz
- Range of Operating Frequency:**  Hz ~  Hz
- Operating Frequency Reference Signal** (automatic signal (4~20mA), manual setting on the control panel, contact signals to increase or decrease speed, etc.)
- Commercial Bypass Operation** (Yes or No)
- Environmental Conditions**  
Ambient Temperature:  ~  °C Relative Humidity:  (%) (Non-condensing)  
Ventilation System (Yes or No) Space Limitation for transportation on site:
- Overload requirement**  
 % of motor rated output for  seconds

## ★ Inverter capacity calculation

If the rated current of the motor that the inverter is going to drive is I (A), and the related voltage V (kV), the necessary capacity of the inverter (kVA) is calculated by

$$\text{Inverter capacity (kVA)} = \sqrt{3} \times V \times I \dots (1)$$

The capacity of inverter must be larger than the capacity calculated from (1).

The rated capacity of TMdrive-MV listed in this catalogue is calculated by

$$\text{Rated capacity (kVA)} = \sqrt{3} \times 3.3 \text{ (or 6.6) kV} \times \text{Maximum continuous current (A)}$$

Therefore, if the output voltage is 3kV (or 6kV), the inverter capacity is

$$\text{Rated capacity} \times 3 / 3.3 \text{ (or Rated capacity} \times 6 / 6.6)$$

which means that the capacity is derated when to use at 3kV.